

**Wicomico County Purchasing Department
125 N. Division Street, Room B-3
Salisbury, Maryland 21801**



INVITATION FOR BID

PROJECT: Cedar Hill Bulkhead Replacement

DEPARTMENT: Recreation Parks & Tourism

VENDOR:

NAME: _____

ADDRESS: _____

BID OPENING:

DATE: Wednesday, January 16, 2019

TIME: 2:30 PM

TABLE OF CONTENTS

SECTION I: INTRODUCTION	3
A. PURPOSE	3
B. CLARIFICATION OF TERMS	3
C. QUESTIONS AND INQUIRES	3
D. FILLING OUT BID DOCUMENTS	3
E. SUBMISSION OF BID DOCUMENTS	3
F. OPENING OF BIDS	4
G. ACCEPTANCE OR REJECTION OF BIDS	4
H. QUALIFICATIONS	5
I. DESCRIPTIVE LITERATURE	5
J. NOTICE TO VENDORS	6
K. PIGGYBACKING	6
SECTION II: GENERAL INFORMATION	7
A. ECONOMY OF BID	7
B. PUBLIC INFORMATION ACT (PIA)	7
C. CONTRACT AWARD	7
D. AUDIT	7
E. NONPERFORMANCE	7
F. MODIFICATION OR WITHDRAWAL OF BID	7
G. DEFAULT	8
H. COLLUSION/FINANCIAL BENEFIT	8
I. TAX EXEMPTION	8
J. CONTRACT CHANGES	8
K. ADDENDUM	9
L. EXCEPTIONS/ SUBSTITUTIONS	9
M. APPROVED EQUALS	9
N. DELIVERY	10
O. INSURANCE	10
P. BID EVALUATION	10
SECTION III: GENERAL CONDITIONS	11
A. DRAWINGS AND SPECIFICATIONS	11
B. MATERIALS, SERVICES AND FACILITIES	11
C. INSPECTION AND TESTING	11
D. APPROVAL OF SUBSTITUTION OF MATERIALS	12
E. PROTECTION OF WORK, PROPERTY AND PERSONS	12
F. BARRICADES, DANGER, WARNING AND DETOUR SIGNS	12
G. LICENSES AND PERMITS	12
H. SUPERVISION	12
I. CLEAN UP	13
J. CHANGES IN WORK	13
K. TIME FOR COMPLETION	13
L. LIQUIDATED DAMAGES	13
M. CORRECTION OF WORK	14
N. CONSTRUCTION SAFETY AND HEALTH STANDARDS	14
O. BID BOND	14
P. PERFORMANCE AND PAYMENT BONDS	14
Q. GUARANTEE	15
SECTION IV: BID SPECIFICATIONS	16
A. SCOPE	16
B. CONTRACT PRICING	16
C. SUMMARY	16
D. GENERAL REQUIREMENTS	16
E. MATERIALS & EQUIPMENT	16
F. METHOD OF WORK	18
G. EXAMINATION	19
H. ATTACHMENTS	19
I. PRE-BID CONFERENCE	19
J. PAYMENT	19
K. QUESTIONS	19
L. AWARD	19
FORM OF BID	20
REFERENCES	21
EXCEPTIONS	22
INDIVIDUAL PRINCIPAL	23
VENDOR'S AFFIDAVIT OF QUALIFICATION TO BID	24
NON-COLLUSIVE AFFIDAVIT	25
EXHIBIT A	26

SECTION I: INTRODUCTION

A. PURPOSE

1. The purpose of this Invitation for Bid Document is for Wicomico County (“County”) to contract for the replacement of 190’ of wooden Bulkhead, Piles and seven (7) Finger Piers (slips 122-135), at Cedar Hill Marina in conformity with the requirements contained herein (“Bid Document(s”).

B. CLARIFICATION OF TERMS

1. Professional firms or individuals that submit a bid for award of a contract (“Contract”) are referred to as vendors (“Vendors”) in this document. The Vendor that is awarded the Contract is herein referred to as the (“Successful Vendor”).

C. QUESTIONS AND INQUIRES

1. Questions must be addressed in writing to Wicomico County Purchasing at purchasing@wicomicocounty.org.
2. The last date to submit questions for clarification will be **noon on January 10, 2019**.
3. Addenda are posted on the County website at www.wicomicocounty.org under Government: Departments: Purchasing: at www.wicomicocounty.org/bids.aspx at least five (5) calendar days before bid opening.
4. It is the Vendors responsibly to make sure all addenda are acknowledged in their bid. Failure to do so could result in the bid being disqualified.

D. FILLING OUT BID DOCUMENTS

1. Use only forms supplied by the County.
2. One (1) unbound original and two (2) bound copies of the bid form and any required attachments must be submitted in the solicitation and can be submitted in the same envelope unless otherwise instructed.
3. Bid Documents should be compiled as follows: (1) Cover letter, (2) Form of Bid, (3) References, (4) Exceptions Document and Signed addenda, if necessary (5) Individual Principal Document, (6) Vendor’s Affidavit of Qualification to Bid, and (7) Non-Collusive Affidavit
4. Where so indicated by the make-up of the Bid Documents, sums will be expressed in both words and figures, and in the case of a discrepancy between the two, the amount written in words will govern. In the event there is a discrepancy between the unit price and the extended totals, the unit prices will govern.
5. Any interlineation, alteration, or erasure will be initialed by the signer of the Bid Documents.
6. Each copy of the Bid Documents will be signed by the person(s) legally authorized to bind the Vendor to a contract, using the legal name of the signer. Bid Documents submitted by an agent will have a current Power of Attorney attached certifying the agent’s authority to bind the Vendor.
7. Vendor will supply all information and submittals required by the Bid Documents to constitute a proper and responsible completed Bid Document package.
8. Any ambiguity in the Bid Documents as a result of omission, error, lack of clarity or non-compliance by the Vendor with specifications, instructions, and/or all conditions of bidding will be construed in the light most favorable to the County.

E. SUBMISSION OF BID DOCUMENTS

1. All copies of the Bid Documents and any other documents required to be submitted with the Bid Documents will be enclosed in a sealed envelope. The envelope will be addressed to the Wicomico County Purchasing Department and will be identified with the project name: **“CEDAR HILL BULKHEAD REPLACEMENT”** and the Vendor’s name and address. If the Bid Documents are sent by mail, the sealed envelope will be enclosed in a separate mailing envelope with the notation **“SEALED BID DOCUMENTS ENCLOSED”** on the face thereof.
2. Bids must be mailed or hand carried to Wicomico County Purchasing Department, 125 N. Division Street, Government Office Building, Room B-3, Salisbury, MD 21801, in order to be received in the office of the Purchasing Agent **prior** to the announced bid deadline. *Bids received after said time or delivered to the wrong location will be returned to the Vendor unopened.*
3. **Bids are due and will be opened at the time listed on the front of this Bid Document.**
4. If you are delivering a bid in person please keep in mind to allow time to sign-in at the security station in the lobby. It is fully the responsibility of the Vendor to insure that the bid is received on time.
5. The County will not speculate as to reasonableness of the postmark, nor comment on the apparent failure of a public carrier to have made prompt delivery of the bid.
6. Vendors, or their authorized agents, are expected to fully inform themselves as to the conditions, requirements, and specifications before submitting Bid Documents; failure to do so will be at the Vendor’s own risk.
7. A fully executed Affidavit of Qualification to Bid will be attached to each Bid Document.
8. **MINORITY VENDORS ARE ENCOURAGED TO PARTICIPATE.**
9. All Vendor submitted Bid Documents will be valid for a minimum of sixty (60) days from the date of Bid Document opening.
10. Electronically mailed bids are **not** considered sealed bids and will **not** be accepted.

F. OPENING OF BIDS

1. Bid Documents received on time will be opened publicly and Vendor’s names and total costs will be read aloud for the record.
2. The Contract will be awarded or all Bid Documents will be rejected within sixty (60) days from the date of the Bid Document opening.

G. ACCEPTANCE OR REJECTION OF BIDS

1. Unless otherwise specified, the Contract will be awarded to the most RESPONSIBLE and RESPONSIVE Vendor complying with the provisions of the Bid Documents, provided the Bid price is reasonable, does not exceed the funds available, and it is in the best interest of the County to accept it. The County reserves the right to reject the Bid Documents of any Vendor who has previously failed to perform properly in any way or complete on time contracts of a similar nature; or a Bid Document from a Vendor who, investigation shows, is not in a position to perform the Contract; or Bid Documents from any person, firm, or corporation which is in arrears or in default to the County for any debt or contract.
2. Completed Bid Documents from Vendors debarred from doing business with the State of Maryland or the Federal Government will not be accepted.
3. In determining a Vendor’s RESPONSIBILITY, the County may consider the following qualifications, in addition to price:

- a. Ability, capacity, and skill to provide the commodities or services required within the specified time, including future maintenance and service, and including current financial statement or other evidence of pecuniary resources and necessary facilities.
 - b. Character, integrity, reputation, experience and efficiency.
 - c. Quality of past performance on previous or existing contracts, including a list of current and past contracts and other evidence of performance ability.
 - d. Previous and existing compliance with laws and ordinances relating to contracts with the County and to the Vendor's employment practices.
 - e. Evidence of adequate insurance to comply with Contract terms and conditions.
 - f. Statement of current work load and capacity to perform/provide the Goods and/or Services.
 - g. Explanation of methods to be used in fulfilling the Contract.
 - h. The Vendor, if requested, will be prepared to supply evidence of its qualifications, listed above, and its capacity to provide/perform the Goods and/or Services; such evidence to be supplied within a specified time and to the satisfaction of the County.
4. In determining a Vendor's RESPONSIVENESS, the County will consider whether the Bid Document conforms in all material respects to the Bid Documents. The County reserves the right to waive any irregularities that may be in its best interest to do so.
 5. The County will have the right to reject any and all Bid Documents, where applicable to accept in whole or in part, to add or delete quantities, to waive any informalities or irregularities in the Bid Document received, to reject a Bid Document not accompanied by required Bid security or other data required by the Bid Documents, and to accept or reject any Bid Document which deviates from specifications when in the best interest of the County. Irrespective of any of the foregoing, the County will have the right to award the Contract in its own best interests.

H. QUALIFICATIONS

1. The Vendor must be in compliance with the laws regarding conducting business in the State of Maryland.
All Vendors shall provide a copy Certificate of Status from the Maryland Department of Assessments and Taxation, evidencing the Vendor is in good standing with the State of Maryland. See https://sdatcert1.resiusa.org/certificate_net/ for information on obtaining the Certificate of Status. *Certificates of status are not available for trade names, name reservations, government agencies, sole proprietorships, and some other accounts as these are not legal entities and thus are not required for these categories of Vendors.* For more information on the Certificate of Status please see <http://www.dat.state.md.us/sdatweb/COSinfo.html> .
2. Wicomico County reserves the right, at its sole discretion, to extend the date this documentation must be provided. The Vendor's inability to provide this documentation could result in the bid being rejected.
3. All Vendors who wish to bid on County projects and contracts need to register as a bidder at www.wicomicocounty.org/list.aspx?Mode=Subscribe#bids by checking off the categories for which you wish to be informed of future bids.

I. DESCRIPTIVE LITERATURE

1. The proposed descriptive literature fully describing the product bid is what is intended to be included as the price. Failure to do so may be cause for rejection of the bid.

2. Any items, systems or devices supplied in this bid that are proprietary in nature relative to maintenance, repair, servicing or updating must be disclosed on the bid form.

J. NOTICE TO VENDORS

1. Before a Vendor submits the Bid Documents it will need to become fully informed as to the extent and character of the Goods and/or Services required and are expected to completely familiarize themselves with the requirements of this Bid Document's specifications. Failure to do so will not relieve the Vendor of the responsibility to fully perform in accordance therewith. No consideration will be granted for any alleged misunderstanding of the material to be furnished or the Services to be performed, it being understood that the submission of a Bid Document is an agreement with all of the items and conditions referred to herein.

K. PIGGYBACKING

1. Wicomico County may authorize, upon request, any governmental entity (hereafter Authorized User) within the County to purchase items under the contract awarded pursuant to this bid solicitation.
2. All purchase orders issued against the contract by an authorized User shall be honored by the Successful Vendor in accordance with all terms and conditions of this contract.
3. The issuance of a purchase order by an Authorized User pursuant to this provision shall constitute an express assumption of all contractual obligations, covenants, conditions and terms of the contract. A breach of the contract by any particular Authorized User shall neither constitute nor be deemed a breach of the contract as a whole which shall remain in full force and effect, and shall not affect the validity of the contract nor the obligations of the Successful Vendor thereunder respecting the County.
4. The County specifically and expressly disclaims any and all liability for any breach by an Authorized User other than the County and each such Authorized User and Successful Vendor guarantee to save the County, its officers, agents and employees harmless from any liability that may be or is imposed by the Authorized User's failure to perform in accordance with its obligations under the contract.

END OF SECTION

SECTION II: GENERAL INFORMATION

A. ECONOMY OF BID

1. Bid Documents will be prepared simply and economically, providing straightforward and concise description of the Vendor's capabilities to satisfy the requirements of the Bid Documents. Emphasis should be on completeness and clarity of content. Elaborate brochures and other representations beyond that sufficient to present a complete and effective Bid Document are neither required nor desired.

B. PUBLIC INFORMATION ACT (PIA)

1. Wicomico County is subject to the Maryland Public Information Act and may be required to release bid submissions in accordance with the Act.
2. Any materials the Vendor deems to be proprietary or copyrighted must be marked as such; however, the material may still be subject to analysis under the Maryland Public Information Act.

C. CONTRACT AWARD

1. A written award by the County to the Successful Vendor in the form of a Purchase Order or other contract document will result in a binding Contract without further action by either party. If the Successful Vendor fails or refuses to sign and deliver the Contract and the required insurance documentation, the County will have the right to award to the next responsible and responsive Vendor. Contract will be executed by the Successful Vendor within fourteen (14) calendar days of receipt of the Contract.
2. Bid Documents and Contracts issued by the County will bind the Vendor to applicable conditions and requirements herein set forth, unless otherwise specified in the Bid Documents, and are subject to all federal, state, and municipal laws, rules, regulations, and limitations.
3. County personal property taxes ("Taxes") must be on a current basis; if any such Taxes are delinquent, they must be paid before award of Contract. Failure to pay will result in the award of Contract to another Vendor.
4. The County reserves the right to engage in individual discussions and interviews with those Vendors deemed fully qualified, responsible, suitable and professionally competent to provide the required Goods and/or Services should the project size warrant it. Vendors will be encouraged to elaborate on their qualifications, performance data, and staff expertise.

D. AUDIT

1. The Successful Vendor agrees to retain all books, records, and other documents relative to the awarded Contract for five (5) years after final payment, or until audited. The County, its authorized agents, and/or State auditors will have full access to and the right to examine any of said materials during said period.

E. NONPERFORMANCE

1. The County reserves the right to inspect all operations and to withhold payment for any goods not performed or not performed in accordance with the specifications in this Bid Document. Errors, omissions or mistakes in performance will be corrected at no cost to the County. Failure to do so will be cause for withholding of payment for that Goods and/or Services. In addition, if deficiencies are not corrected in a timely manner, the County may characterize the Successful Vendor as uncooperative, which may jeopardize future project order solicitations.

F. MODIFICATION OR WITHDRAWAL OF BID

1. A Bid Document may not be modified, withdrawn, or cancelled by the Vendor during the stipulated time period following the time and date designated for the receipt of Bid Documents, and each Vendor so agrees in submitting Bid Documents.

G. DEFAULT

1. The Contract may be cancelled or annulled by the County in whole or in part by written notice of default to the Successful Vendor upon non-performance, violation of Contract terms, delivery failure, bankruptcy or insolvency, any violation of state or local laws, or the making of an assignment for the benefit of creditors. An award may then be made to the next most highly rated Vendor, or when time is of the essence, similar commodities and/or service may be purchased on the open market. In either event, the defaulting Vendor (or his surety) will be liable to the County for cost to the County in excess of the defaulted Contract price.
2. If a representative or warranty of either Party to the Contract is false or misleading in any material respect, or if either Party breaches a material provision of the Contract (“Cause”), the non-breaching Party will give the other Party written notice of such cause. If such Cause is not remedied within fifteen (15) calendar days (“Cure Period”) after receipt of such notice, (unless, with respect to those Causes which cannot be reasonably corrected or remedied within the Cure Period, the breaching Party will have commenced to correct or remedy the same within such Cure Period and thereafter will proceed with all due diligence to correct or remedy the same), the Party giving notice will have the right to terminate this Contract upon the expiration of the Cure Period.

H. COLLUSION/FINANCIAL BENEFIT

1. The Vendor certifies that his/her Bid is made without any previous understanding, agreement, or connection with any person, firm, or corporation making a Bid Document for the same project; without prior knowledge of competitive prices; and is in all respects fair, without outside control, collusion, fraud, or otherwise illegal action.
2. Upon signing the Bid Document, Vendor certifies that no member of the governing body of the County, or members of his/her immediate family, including spouse, parents or children, or any other officer or employee of the County, or any member or employee of a Commission, Board, or Corporation controlled or appointed by the Executive or Council has received or has been promised, directly or indirectly, any financial benefit, related to this Bid Document and subsequent Contract.

I. TAX EXEMPTION

1. In buying products directly from a Vendor Wicomico County is exempt from being *directly* charged Federal excise and Maryland sales tax. A copy of an exemption certificate shall be furnished upon request.
2. According to the Office of the Comptroller of Maryland, a *Contractor is responsible for paying sales tax* on his/her purchases relating to any projects or services and should incorporate it into their bid.
3. Successful Vendors cannot use the County tax exemption to buy materials or products used on County projects.

J. CONTRACT CHANGES

1. NO CLAIMS may be made by anyone that the scope of the project or that the Vendor’s Goods and/or Services have been changed (requiring changes to the amount of compensation to the Vendor or other adjustments to the Contract) UNLESS such changes or adjustments have been made by an approved WRITTEN AMENDMENT (Change Order) to the Contract signed by the

Purchasing Agent (and the County Council, if required), prior to additional Goods and/or Services being initiated. Extra Goods and/or Services performed without prior, approved, written authority will be considered as unauthorized and at the expense of the Vendor. Payment will not be made by the County.

2. NO ORAL conversations, agreements, discussions, or suggestions, which involve changes to the scope of the Contract, made by anyone including any County employee, will be honored or valid. No written agreements or changes to the scope of the Contract made by anyone other than the Purchasing Agent (with County Council approval, if required) will be honored or valid.
3. If any Change Order in the Goods and/or Services results in a reduction in the Goods and/or Services, the Vendor will neither have, nor assert any claim for, nor be entitled to any additional compensation for damages or for loss of anticipated profits on Goods and/or Services that are eliminated.

K. ADDENDUM

1. No oral statements of any person will modify or otherwise affect or interpret the meaning of the Contract specifications, or the terms, conditions, or other portions of the Contract. All modifications and every request for any interpretation must be addressed to the Wicomico County's Purchasing Agent and to be given consideration, must be received no later than the last day for questions listed in Section I, Subsection C.2.
2. Any and all interpretations, corrections, revisions, and amendments will be issued by the Purchasing Agent to all holders of Bid Documents in the form of written addenda. Vendors are cautioned that any oral statements made by any County employee that materially change any portion of the Bid Documents will not be relied upon unless subsequently ratified by a formal written amendment to the Bid Document.
3. All addenda will be issued so as to be received at least five (5) days prior to the time set for receipt of Bid Documents, and will become part of the Contract and will be acknowledged in the Bid Document form. Failure of any Vendor to receive any such addenda will not relieve said Vendor from any obligation under the Bid Document as submitted.
4. Vendors are cautioned to refrain from including in their Bid Document any substitutions which are not confirmed by written addenda. To find out whether the County intends to issue an amendment reflecting an oral statement made by any employee, contact the Wicomico County's Purchasing Agent during normal business hours.
5. The Wicomico County Purchasing Agent reserves the right to postpone the Bid Document opening for any major changes occurring in the 5-day interim which would otherwise necessitate an Addendum.

L. EXCEPTIONS/ SUBSTITUTIONS

1. Any exceptions or substitutions to the specifications requested should be marked on the bid form and listed on a separate sheet of paper attached to the bid.
2. An exception to the specifications may disqualify the bid. The County will determine if the exception is an essential deviation or a minor item.
3. In the case of a minor deviation, the County maintains the option to award to that Vendor if it determines the performance is not adversely affected by the exception.

M. APPROVED EQUALS

1. In all specifications where a material or article is defined by describing a proprietary product or by using the name of a Vendor or manufacturer, it can be assumed that an approved equal can be substituted.
2. The use of a named product is an attempt to set a particular standard of quality and type that is familiar to the County. Such references are not intended to be restrictive.
3. However, the County shall decide if a product does in fact meet or exceed the quality of the specifications listed in the solicitation. It shall be the responsibility of the Vendor that claims his product is an equal to provide documentation to support such a claim.

N. DELIVERY

1. All items shall be delivered F.O.B. destination and delivery costs and charges included in the bid unless otherwise stated in the specifications or bid form.

O. INSURANCE

1. If required by the General Conditions or Terms and Conditions, the Successful Vendor shall provide the County with Certificates of Insurance within ten (10) calendar days of bid award notification evidencing the required coverage.
2. Successful Vendor must provide Certificates of Insurance before commencing work in connection with the Contract.

P. BID EVALUATION

1. If some characteristic of the bid requires that the bid must be reviewed by the County Council, the award can be expected within 30 calendar days.
2. Bid tabulations will be posted on the County website at www.wicomicounty.org/bids.aspx and click on the box Show Closed/Awarded/Cancelled Bids and find the bid tabulation for the bid you are interested in. Bid tabulations will be posted as soon as reasonably possible after the Bid opening.

END OF SECTION

SECTION III: GENERAL CONDITIONS

A. DRAWINGS AND SPECIFICATIONS

1. Should any detail be omitted from the drawings or specifications, or should any errors appear in either, it shall be the duty of the Successful Vendor to notify the County's designated construction inspector.
2. In no case shall the Successful Vendor proceed with the work without notifying and receiving definite instructions from the County. Work wrongly constructed without such notification shall be corrected by the Successful Vendor at his own cost.

B. MATERIALS, SERVICES AND FACILITIES

1. It is understood that, except as otherwise specifically stated in the Bid Documents, the Successful Vendor will provide and pay for all materials, labor, tools, equipment, water, light, power and transportation, supervision, temporary construction of any nature, and all other services and facilities of any nature whatsoever necessary to execute, complete, and deliver the Work within the specified time.
2. Materials and equipment will be so stored as to insure the preservation of their quality and fitness for the Work. Stored materials and equipment to be incorporated in the Work will be located so as to facilitate prompt inspection.
3. Manufactured articles, materials, and equipment will be applied, installed, connected, erected, used, cleaned and conditioned as directed by the manufacturer.
4. Materials, supplies and equipment will be in accordance with samples submitted by the Successful Vendor and approved by the County.

C. INSPECTION AND TESTING

1. All materials and equipment used in the construction of the Work will be subject to adequate inspection and testing in accordance with generally accepted standard, as required and defined in the Bid Documents.
2. The County or its representatives may, at any time, enter upon the work and the premises used by the Successful Vendor, and the Successful Vendor shall provide proper and safe facilities to secure convenient access to all parts of the work, and all other facilities necessary for inspection, as may be required.
3. The County will appoint such persons as deemed necessary to properly inspect the materials furnished or to be furnished, and the work done under the contract and to see that the same strictly corresponds with the drawings and specifications. All such materials and workmanship shall be subject to approval of the County. Approval or acceptance of payment shall not be misconstrued as approval of items or work not in conformance with specifications and drawings nor shall it prevent the rejection of said work or materials at any time thereafter during the existence of the contract, should said work or materials be found to be defective, or not in accordance with the requirements of the contract.
4. Work and material will be inspected promptly, but if for any reason should a delay occur, the Successful Vendor shall have no claim for damages or extra compensation.
5. The Successful Vendor shall pay for all inspection costs necessary to complete the work which may be incurred to comply with the requirements of any agency other than the County, such as a railroad, public service utility company, or any other governmental agency or any other agency whose jurisdiction affects the work in any manner unless otherwise specified herein.

D. APPROVAL OF SUBSTITUTION OF MATERIALS

1. Samples of materials shall be submitted by the Successful Vendor for approval before such materials are ordered from the manufacturers or distributors and shall be approved by the County before actual work is begun.
2. It is the intention of these specifications to permit all vendors bidding on this work to secure the fullest amount of competition on the various materials and specialties names herein. Wherever a material or article is defined by describing a proprietary product or by using the name of a vendor or manufacturer, the term or approved equal shall be presumed to be implied unless otherwise stated.

E. PROTECTION OF WORK, PROPERTY AND PERSONS

1. Successful Vendor will be responsible for initiating, maintaining and supervising all safety precautions and programs in connection with the Work. Successful Vendor will take all necessary precautions and programs in connection with the Work. Successful Vendor will take all necessary precautions for the safety of, and will provide the necessary protection to prevent damage, injury or loss to all employees on the Work and other persons who may be affected thereby, all the Work and all materials or equipment to be incorporated therein, whether in storage on off the site, and other property at the site or adjacent thereto, including trees, shrubs, lawns, walks, pavements, roadways, structures and utilities not designated for removal, relocation or replacement in the course of construction.
2. Successful Vendor will comply with all applicable laws, ordinances, rules, regulations and orders of any public body having jurisdiction. Successful Vendor will erect and maintain, as require by the conditions and progress of the Work, all necessary safeguards for safety and protection. Successful Vendor will notify owners of adjacent utilities when progress of the Work may affect them. The Successful Vendor will remedy all damage, injury or loss to any property caused, directly or indirectly, in whole or in part, by Successful Vendor, any Subcontractor or anyone directly or indirectly employed by any of them or anyone for whose acts any of them be liable.
3. In emergencies affecting the safety of persons or the Work or property at the site or adjacent thereto, the Successful Vendor, without special instruction or authorization from the County, will act to prevent threatened damage, injury or loss. Successful Vendor will give the County prompt Written Notice of any significant changes in the Work or deviations from the Bid Documents caused thereby, and a Change Order will thereupon be issued covering the changes and deviations involved.

F. BARRICADES, DANGER, WARNING AND DETOUR SIGNS

1. The Successful Vendor shall provide, erect and maintain all necessary barricades, sufficient red lights, flares, danger signals and signs, provide a sufficient number of watchmen and take all necessary precautions for the protection of the work and safety of the public.

G. LICENSES AND PERMITS

1. The Successful Vendor shall have all necessary licenses required to do the work and give all notices and obtain and pay all necessary permits required by local laws and regulations for building.
2. State and Federal permits (if applicable) to undertake work have been obtained by the County and accompany these specifications.

H. SUPERVISION

1. The Successful Vendor shall maintain, at all times during the progress of work, a competent and experienced supervisor who shall represent the Successful Vendor, and all directions given to him shall be binding. Important decisions of any directions, if requested by the supervisor, shall be confirmed in writing.
2. Supervision by the County or its representative does not relieve the Successful Vendor of responsibility for defective work executed under the direct control of the Successful Vendor. Responsibility for defective work rests upon the Successful Vendor, whether discovered by the County prior to final payment or subsequent thereto.

I. CLEAN UP

1. Upon completion of the items within a given location as specified and before monthly estimates will be paid, the construction area and all other areas occupied by the Successful Vendor during the construction of said Contract shall be cleaned of all surplus and discarded materials, bracing, forms, rubbish and temporary structures that were placed there by the Successful Vendor.
2. Disposal of the aforementioned shall be the responsibility of the Successful Vendor.

J. CHANGES IN WORK

1. The County, without invalidating the contract, may order extra work or make changes by altering, adding or deducting from the work with the contract sum being adjusted accordingly.
2. All such work shall be executed under the conditions of the original contract, except that any claim for the extension of time caused thereby shall be adjusted at the time of ordering such change.
3. The value of any such extra work or change shall be determined in one or more of the following ways:
 - a. By estimate and acceptance of lump sum.
 - b. By unit prices named in the contract or subsequently agreed upon.

K. TIME FOR COMPLETION

1. The Work contemplated under this Contract shall be considered as continuous and be completed within the timeframe(s) stated in Section IV of this Bid Document.
2. The Successful Vendor will be allowed to work eight (8) hours per day, Monday through Friday, except for holidays, 52 weeks per year.
3. The Successful Vendor will not be permitted to work on holidays observed by Wicomico County or the State of Maryland or on Sundays unless otherwise authorized in writing.
4. In case of an emergency which may require that work be done on Saturdays, Sundays, and Holidays, the Successful Vendor shall request permission of the County to do so. If, in the opinion of the County, the emergency is bonafide, permission may be granted to the Successful Vendor to work such hours as may be necessary. Also if in the opinion of the County a bonafide emergency exists, the Successful Vendor may be directed to work such hours as may be necessary whether or not the Successful Vendor requests permission to do so.
5. The Successful Vendor shall pay the County for all costs incurred for inspection services required for work permitted during holidays, weekends or in excess of eight (8) hours per day.

L. LIQUIDATED DAMAGES

1. If the Successful Vendor shall fail to start and complete the project within the time frame stated above, the County shall assess liquidated damages in the amounts listed below per calendar day for each and every day the Successful Vendor fails to complete the contract.

<u>Amount of Contract</u>	<u>Liquidated Damages per Day</u>
Less than \$10,000	\$100.00
\$10,000 or less than \$100,000	\$250.00
\$100,000 or less than \$500,000	\$750.00
\$500,000 or more	\$1,000.00
Or will be based on actual cost to the County, whichever is greater.	

2. The designated County project manager reserves the option to extend the scheduled completion date or waive the liquidated damages clause in its entirety if he is of the opinion that extenuating circumstances deemed such action appropriate.

M. CORRECTION OF WORK

1. The Successful Vendor will promptly remove from the premises all Work rejected by the County for failure to comply with the Bid Documents, whether incorporated in the construction or not, and the Successful Vendor will promptly replace and re-execute the Work in accordance with the Bid Documents and without expense to the County and will bear the expense of making good all Work of other Vendors destroyed or damaged by such removal or replacement.
2. All removal and replacement Work will be done at the Successful Vendor's expense. If the Successful Vendor does not take action to remove such rejected Work within ten (10) days after receipt of Written Notice, the County may remove such Work and store the materials at the expense of the Successful Vendor.

N. CONSTRUCTION SAFETY AND HEALTH STANDARDS

1. It is a condition of this contract, and shall be made a condition of each sub-contract entered into pursuant to this contract, that the Successful Vendor and any sub-contractor shall not require any laborer or mechanic employed in performance of the contract to work in surroundings or under working conditions which are unsanitary, hazardous, or dangerous to his health or safety, as determined under construction safety and health standards (Title 29, Code of Federal Regulations, Part 1926, formerly Part 1518, as revised from time to time, promulgated by the United States Secretary of Labor, in accordance with Section 107 of the Contract Work Hours and Safety Standard Act.) (83 Stat. 96).
2. Failure of Wicomico County to inform the Successful Vendor of safety violations will not release the Successful Vendor of his responsibilities.

O. BID BOND

1. Bid Documents must be accompanied by a Bid Bond if the Vendor's total Bid amount exceeds \$100,000, payable to the County for five (5%) percent of the total amount of the bid. After the analysis of the Bid Documents the County will return Bid Bonds to all Vendors except the three (3) lowest Responsive and Responsible Vendors. After execution of the Contract, and receipt, execution, and approval of the Successful Vendor's Payment and Performance bond, the Bid Bonds will be returned. A certified check may be used in lieu of a Bid Bond.
2. The County, at its discretion, may consider a Vendor in default if the Vendor fails to execute the Contract, in which the County will retain said Bid Bond.

P. PERFORMANCE AND PAYMENT BONDS

1. The Successful Vendor will be required to provide the County with a Performance Bond and Payment Bond if their total Bid amount exceeds \$100,000, each in the amount of one hundred

percent (100%) of the Contract Price, with a corporate surety approved by the County for the faithful performance of the Contract.

2. The Successful Vendor will within fourteen (14) calendar days after the receipt of the Contract furnish the County with a Performance Bond and Payment Bond in penal sums equal to the amount of the Contract Price, conditioned upon the performance by the Successful Vendor of all undertakings, covenants, terms, conditions and agreements of the Bid Documents, and upon the prompt payment by the Successful Vendor to all persons supplying labor and materials in the prosecution of the Work provided by the Bid Document. Such Bonds will be executed by the Successful Vendor and corporate bonding company licensed to transact such business in the state in which the Work is to be performed and named on the current list of "Surety Companies Acceptable on Federal Bonds" as published in the Circular Number 570. The expense of these Bonds will be borne by the Successful Vendor. If at any time a surety on any such Bond is declared bankrupt or loses its right to do business in the State of Maryland OR IS REMOVED FROM THE LIST OF SURETY COMPANIES ACCEPTED ON FEDERAL BONDS, Successful Vendor will within ten (10) calendar days after notice from the County TO DO SO, SUBSTITUTE AN ACCEPTABLE Bond(s) in such form and sum and signed by such other surety or sureties as may be satisfactory to the County.

Q. GUARANTEE

1. The Successful Vendor shall furnish the County with a one-year guarantee of workmanship and materials, dating from time of acceptance of the project and shall make good any defects which may occur during that period.
2. If any special guarantees in excess of the one-year period are specified by the manufacturer, these guarantees shall take precedence over the one-year period guarantee.
3. Upon completion of work, and before final payment or release of retainage, submit, and obtain from each subcontractor, material supplier and equipment manufacture general warranties and a notarized asbestos free guarantee.

END OF SECTION

SECTION IV: BID SPECIFICATIONS

A. SCOPE

1. The County is seeking bids from qualified Vendors to contract for the replacement of 190' of wooden Bulkhead, Piles and seven (7) Finger Piers (slips 122-135), at Cedar Hill Marina in accordance with the terms and conditions and specifications set forth in this solicitation.

B. CONTRACT PRICING

1. Contract pricing will be valid for the term of the contract, ("Contract Period").
2. Pricing must include all labor, materials, tools, and equipment to perform Work.
3. Pricing will not change during the Contract Period.

C. SUMMARY

1. It is the purpose of Wicomico County Department of Recreation Parks & Tourism to have a replacement project of a one-hundred & ninety (190') foot of selected bulk heading, piles and finger piers (slips 122-134) at Cedar Hill Marina, 20945 Harbor view Road, Bivalve, Maryland, 21814.
2. The existing bulkhead to remain in place as seen on plans.
3. The county has the Tidal Wetland permit in hand for this project.
4. All Work must be completed on or before April 1, 2019.

D. GENERAL REQUIREMENTS

1. PILES
 - a. All pile replacement will be done in a way to keep the boat slips as existing and the widths the same from front to back.
 - b. The pile elevation will be left approximately 6' above the catwalk elevation.
 - c. Any piles that are broken off during removal shall be cut off at the mudline.
2. FINGER PIERS
 - a. Old finger piers shall be removed and disposed of.
 - b. All finger piers will be rebuilt as before with the use of a 5/8 double dipped galvanized domed bolt securing the stringers to the pile.
 - c. Countersunk holes shall be just enough so that the nut does not protrude the hole.
 - d. Boards are to be upside down.
3. The new bulkhead shall be 18" channel ward of the existing bulkhead and pilings.
4. The elevation of the new bulkhead shall be the same as the existing bulkhead.
5. The Successful Vendor will be responsible for removal of all debris.
6. Replace hardware and fasteners as needed as per material specifications.
7. The Successful Vendor must be licensed to perform Work in the state of Maryland.

E. MATERIALS & EQUIPMENT

1. All materials shall be as specified, or approved equal by the Superintendent of Parks or his Assistant. In the event the SUCCESSFUL VENDOR would like to substitute materials other than those that have been specified, the SUCCESSFUL VENDOR shall submit to the Superintendent of Parks or his Assistant all pertinent data to determine the or-equal status. This material shall be submitted to the Superintendent of Parks or his Assistant a minimum of ten (10) days prior to the bid opening. The Superintendent of Parks or his Assistant shall notify the SUCCESSFUL VENDOR within five (5) days as to the or-equal status.
2. As applicable, all materials shall be new and shall be delivered to the job site with labels intact and legible. The SUCCESSFUL VENDOR shall be responsible for the proper storage of said materials throughout the project and shall replace, at no additional cost to

- the County any supplies or materials judged unacceptable by the Superintendent of Parks or his Assistant.
3. The SUCCESSFUL VENDOR shall be responsible for the coordination, off-loading, and proper storage of all materials and supplies up until the time of final inspection and project acceptance.
 4. All connection hardware shall be hot dipped galvanized steel in accordance with ASTM A-153. Bolts shall be hot forged with hexagonal heads and meet ASTM Specification A 307 for Grade A steel.
 5. Nuts shall be hexagonal and meet ASTM Specification A 307 for Grade A Steel.
 6. NYDD and standard cut washers shall be fabricated from a commercial grade steel and conform to ASTM Specification Designation F844 83 with the exception that galvanizing shall be as per this specification.
 7. Spikes and nails shall be the common wire type and shall meet AISI Specifications 1010 or 1020 for steel.
 8. Piles shall meet the requirements of the ASTM D25 "Standard Specifications for Round Timber Piles", latest edition, for size, circumference, sapwood, straightness, etc. except as modified by the Drawings and Specifications.
 9. Piles shall be 10" in diameter, 30 ft. long with little taper and shall have a minimum of 2.5 PCF of CCA Type C (Copper Chromium Arsenate) treatment in accordance with AWPA Standard P5. Application of treatment shall conform to AWPA Standards C I, C2 and C3 for lumber subject to marine borer exposure.
 10. The finger pier stringers will be 1.5 pcf CCA
 11. The finger pier decking will be .1 copper azole
 12. Timber: All timber shall be Southern Yellow Pine (SYP), unless approved by the Superintendent of Parks or his Assistant, kiln dried, No.1 Structural (Fy> 1200 PSI) grade, free from all defects which will impair its strength and durability .All timber shall comply with the AWPA, last edition.
 13. Mirafi 700X filter cloth will be used continuously with an 8 in edge lap. It will extend a minimum of 18 inches below bottom. There will not be an edge lap closer than 6 ft from a bulkhead bend or corner.
 14. Sheeting will be 16 ft. long
 15. 1 cubic foot of gravel will be enclosed in filter cloth and be placed on the landward side of each weep hole.
 16. Piles will be placed 6 ft. 6 inches on center
 17. All dimensional lumber shall be graded and carry an identifiable grade mark in accordance with the Grading Rules of the SPIB. All lumber shall be Grade No.1 minimum, (MC < 19%), Fb = 1,500 psi minimum before treatment, and surfaced on four sides (S4S).
 18. Wales shall have sapwood all four sides.
 19. All timber and dimensional lumber specified shall be treated per the American Wood Preservers Bureau (AWPB). Piles, wales and sheeting shall have a minimum of 2.5 PCF of CCA Type C (Copper Chromium Arsenate) treatment in accordance with AWPA Standard P5. Application of treatment shall conform to AWPA Standards C1, C2 and C3 for lumber subject to marine borer exposure. The cap board shall be treated to a minimum of 1.0 PCF of CCA Type C noted above.
 20. Prior to delivery of materials to the construction site, the SUCCESSFUL VENDOR shall supply to the Superintendent of Parks or his Assistant:

- a. A notarized Certificate attesting to the fact that all timber meets the requirements of the Drawings and specifications as to species, grade, strength, finish and size.
- b. A notarized Certificate of Treatment from the supplier indicating that all timber meets the Specifications as to type and amount of retention of preservative treatment.
- c. A notarized Certification of indicating that all hardware meets these specification as to galvanizing and steel type. The certificate shall list the materials in detail.

21. Backfill material shall be a free draining, clean, granular (sand) material.

F. METHOD OF WORK

- 1. All work shall be as called for in these written specifications.
- 2. The SUCCESSFUL VENDOR shall adhere to OSHA MOSHA regulations throughout the project to insure the safety of his/her employees, state employees, and the public.
- 3. The SUCCESSFUL VENDOR shall maintain the work site in a safe, neat, and orderly manner throughout the entire project. The SUCCESSFUL VENDOR shall take steps necessary to prevent the accumulation of debris at the job site.
- 4. BULKHEAD:
 - a. Timber retaining wall: The SUCCESSFUL VENDOR shall install the timber retaining walls in accordance with these specifications and the drawings. The piles shall be driven into place plumb and level to the specified depth by gravity, steam or diesel hammer. Driving shall be continuous without intermission until the pile has been driven to the required penetration. Jetting will be held to a minimum and not be permitted in soft material. Jetting or auguring is permissible in hard material, but the last two (2) feet of penetration must be driven without damage to the pile.
 - b. Tops of piles shall be trimmed. One (1) inch weep holes will be placed every six (6) feet six (6) inches, centered between each pile.
 - c. All wale splices will be treated with roofing cement before assembly.
 - d. All bolt holes shall be of a minimum diameter to assure a tight and driving fit. Holes shall be of a diameter such that bolts are inserted by light tapping. All counter bore holes for the installation of the washers shall not be more than 1.0 inch.
 - e. Damage to the top of the sheeting and the tongues and grooved edges shall be minimized. The top of the sheeting shall be protected during driving by using a cap. The maximum allowable cut off of sheeting to the top wale elevation shall not be more than 6 inches for damaged material. Ends of sheeting shall be waterproofed with a coating of Clipper Ship Rooting Cement MP 51 or equivalent.
 - f. Each decking board and stiffener shall be secured with 2-20d. galvanized nails per end. If necessary nail holes shall be pre drilled to prevent splitting of boards.
- 5. PILES:
 - a. Each pile is expected to provide adequate pile bearing capacity. If during driving operations the SUCCESSFUL VENDOR finds inadequate bearing on piles he shall stop driving and immediately notify the Superintendent of Parks or his Assistant.
 - b. Broken or shattered piles shall not be accepted. Piles shall not be more than 2% out of plumb. Piles damaged by over driving or which do not conform to the

above tolerances shall be removed and replaced with new piles at the SUCCESSFUL VENDOR's expense.

- c. Field cuts, trimmed areas and holes of CCA treated timber shall be given a treatment of an approved water-borne preservative solution of CCA- Type C.
- d. Pile tops shall receive, after trimming, shall be capped with a conehead black polyethylene cap.

6. **FINGER PIERS** (7 piers to be replaced)

- a. The finger pier decking will be placed upside down with two (2) 20D double dipped galvanized nails securing each end of the board.
- b. All finger piers will be rebuilt as before with the use of a 5/8 double dipped galvanized domed bolt securing the stringers to the pile.
- c. Countersunk holes shall be just enough so that the nut does not protrude the hole.

7. **RESTORATION OF DISTURBED AREAS:**

- A. The disturbed and graded areas shall be dressed and seeded with K31 fescue at a rate of 6 pounds per 1000 sq. ft. Apply 10-10-10 fertilizer at the rate of 25 to 30 pounds per 1,000 sq. ft, worked into the top two inches of soil. The seeded area shall be mulched with an un-weathered, un-chopped small grain straw at the rate of 70 -90 pounds per 1,000 sq. ft.
- B. Asphalt replacement. The existing asphalt road may be disturbed. Any area of the road that is disturbed will need to be replaced and restored using current approved specifications for asphalt parking lot construction.

G. EXAMINATION

- 1. Successful Vendor shall inspect existing conditions and defects that will adversely affect quality of work, and which cannot be put into an acceptable condition through normal preparatory work as specified.

H. ATTACHMENTS

- 1. Cedar Hill Bulkhead Specifications.

I. PRE-BID CONFERENCE

- 1. A Pre-bid Conference is scheduled at 11:00 am on Tuesday, January 8, 2019 at the site; Cedar Hill Marina, 20945 Harbor view Road, Bivalve, Maryland, 21814.

J. PAYMENT

- 1. The County will make payment(s) to the Successful Vendor within thirty (30) calendar days from the receipt of a proper invoice for approved and accepted work performed.

K. QUESTIONS

- 1. The last day for questions is listed under Section I, Subsection C.2.

L. AWARD

- 1. The County intends to award to the lowest Responsive and Responsible Vendor meeting the specifications.

END OF SECTION

THIS AND PREVIOUS SECTIONS, OTHER THAN THE COVER PAGE, DO NOT NEED TO BE RETURNED WITH SUBMITTAL

FORM OF BID

To whom it may concern:

We hereby submit our Bid Documents for “CEDAR HILL BULKHEAD REPLACEMENT” as indicated in the Bid Documents. Having carefully examined the Bid Documents and having received clarification on all items of conflict or upon which any doubt arose, the undersigned hereby requests consideration of our Vendor for award of the referenced Bid.

ITEM	DESCRIPTION	LUMP SUM
1	Provide labor, materials and equipment for the Replacement of 190 feet of Bulkhead, piles and finger piers (slips 122-134) at Cedar Hill Marina as stated in the Bid Specifications.	

Vendor agrees to have the Work completed on or before April 1, 2019. (Yes)____ (No) _____
CHECK One.

Is your company currently involved in any active litigation? (Yes)____ (No) _____ CHECK One.

Is your company currently involved in any mergers or acquisitions? (Yes)____ (No) _____ CHECK One.

The Vendor agrees that their bid will be good for at least sixty (60) days unless otherwise indicated in the bid specifications.

NOTE: THIS BID FORM MUST BE SIGNED BY AN OFFICER OF YOUR COMPANY OR AN AUTHORIZED AGENT FOR THIS BID TO BE CONSIDERED VALID BY THE COUNTY.

Sign for Identification

Printed Name

Title

Email

REFERENCES

List three (3) references for which the Vendor has provided Goods/Services similar to those requested in the Bid Document within the last 12-36 months. Include contact name, address, telephone number, email address and services provided.

Company Name:		Company Name:	
Type of Project:		Type of Project:	
Address:		Address:	
Town, State, Zip Code:		Town, State, Zip Code:	
Contact Person:		Contact Person:	
Telephone Number:		Telephone Number:	
Email:		Email:	
Date of Service:		Date of Service:	
Company Name:			
Type of Project:			
Address:			
Town, State, Zip Code:			
Contact Person:			
Telephone Number:			
Email:			
Date of Service:			

Sign for Identification

Printed Name

EXCEPTIONS

The undersigned hereby certifies that, except as listed below, or on separate sheets attached hereto, the enclosed Completed Bid Document covers all items as specified.

EXCEPTIONS:

(If none, write NONE) _____

THE VENDOR HEREBY ACKNOWLEDGES RECEIPT OF THE FOLLOWING ADDENDA.

<u>Number</u>	<u>Date</u>	<u>Initials</u>
_____	_____	_____
_____	_____	_____
_____	_____	_____

Sign for Identification

Printed Name

INDIVIDUAL PRINCIPAL

Vendor Name: _____

Signed By: _____ In the presence of: _____

Address of Vendor: _____ Town, State, Zip _____

Telephone No.: _____ Fax: _____ Email: _____

CO-PARTNERSHIP PRINCIPAL

Name of Co-Partnership: _____

Address: _____ Town, State, Zip

Telephone No.: _____ Fax: _____

Signed By: _____ In the presence of: _____

Partner

Witness

Signed By: _____ In the presence of: _____

Partner

Witness

Signed By: _____ In the presence of: _____

Partner

Witness

CORPORATE PRINCIPAL

Name of Corporation: _____

Address: _____ Town, State, Zip

Telephone No.: _____ Fax: _____

Signed By: _____ In the presence of: _____

President

Witness

Attest: _____

Corporate Secretary

Affix Corporate Seal

VENDOR'S AFFIDAVIT OF QUALIFICATION TO BID

I HEREBY AFFIRM THAT:

I, _____ am the _____
(Printed Name) (title)
and the duly authorized representative of the Vendor of
_____ whose address is
(name of corporation)

and that I possess the legal authority to make this affidavit on behalf of myself and the Vendor for which I am acting.

Except as described in paragraph 3 below, neither I nor the above Vendor, nor to the best of my knowledge and of its officers, directors or partners, or any of its employees directly involved in obtaining contracts with the State or any county, bi-county or multi-county agency, or subdivision of the State have been convicted of, or have pleaded nolo-contendere to a charge of, or have during the course of an official investigation or other proceeding admitted in writing or under oath acts or omissions which constitute bribery, attempted bribery, or conspiracy to bribe under the provisions of Article 27 of the Annotated Code of Maryland or under the laws of any state or federal government (conduct prior to July 1, 1977 is not required to be reported).

(State "none" or, as appropriate, list any conviction, plea or admission described in paragraph 2 above, with the date, court, official or administrative body, the individuals involved and their position with the Vendor, and the sentence or disposition, if any.)

I acknowledge that this affidavit is to be furnished to the County, I acknowledge that, if the representations set forth in this affidavit are not true and correct, the County may terminate any Contract awarded and take any other appropriate action. I further acknowledge that I am executing this affidavit in compliance with section 16D of Article 78A of the Annotated Code of Maryland, which provides that certain persons who have been convicted of or have admitted to bribery, attempted bribery or conspiracy to bribe may be disqualified, either by operation of law or after a hearing, from entering into contracts with the State or any of its agencies or subdivisions.

I do solemnly declare and affirm under the penalties of perjury that the contents of this affidavit are true and correct.

Sign for Identification

Printed Name

NON-COLLUSIVE AFFIDAVIT

_____ being first duly sworn,
deposes and says that:

1. He/she is the _____, (Owner, Partner, Officer, Representative or Agent) of _____, the Vendor that has submitted the attached Bid Documents;
2. He/she is fully informed respecting the preparation and contents of the attached Bid Document and of all pertinent circumstances respecting such Bid Documents;
3. Such Bid Document is genuine and is not a collusive or sham Bid Document;
4. Neither the said Vendor nor any of its officers, partners, owners, agents, representatives, employees or parties in interest, including this affiant, have in any way colluded, conspired, connived or agreed, directly or indirectly, with any other Vendor, firm, or person to submit a collusive or sham Bid Document in connection with the Work for which the attached Bid Document has been submitted; or to refrain from bidding in connection with such Work; or have in any manner, directly or indirectly, sought by agreement or collusion, or communication, or conference with any Vendor, firm, or person to fix the price or prices in the attached Bid Document or of any other Vendor, or to fix any overhead, profit, or cost elements on the Bid Document price or the Bid Document price of any other Vendor, or to secure through any collusion, conspiracy, connivance, or unlawful agreement any disadvantage against (Recipient), or any person interested in the Work;
5. The price or prices quoted in the attached Bid Document are fair and proper and are not tainted by any collusion, conspiracy, connivance, or unlawful agreement on the part of the Vendor or any other of its agents, representatives, owners, employees or parties in interest, including this affiant.

Signed, sealed and delivered in the presence of:

Witness

Witness

By: _____
Signature

Printed Name

Title

EXHIBIT A

WICOMICO COUNTY MARYLAND STANDARD TERMS AND CONDITIONS

The provisions below are applicable to all Wicomico County (“County”) contracts. These provisions are not a complete agreement. The provisions must be attached to an executed document that identifies the work to be performed, compensation, term, incorporated attachments, and any special conditions.

This document and the Contract are intended to be complementary. If the terms and conditions and the Contract conflict, then the Contract will prevail.

The term “Contract” includes a document entitled “agreement” or other title denoting a contract. The Wicomico County Executive is the person authorized to enter contracts for Wicomico County.

Amendment. This Contract is the entire agreement between the parties. All other prior communications related to this Contract are superseded by this Contract. No amendment to this Contract is binding unless in writing and signed by the parties.

Bankruptcy. Upon the filing of a bankruptcy proceeding by or against the Contractor or upon the appointment of a receiver, trustee, or assignee for the benefit of creditors:

- A. The Contractor must notify the County immediately; and
- B. The County may cancel the Contract or affirm the Contract and hold the Contractor responsible for damages.

Compliance with Law. The Contractor warrants that:

- A. The executed Contract will be a valid obligation enforceable in accordance with its terms;
- B. Contractor will perform in a workmanlike manner and in accordance with applicable professional standards;
- C. Contractor is qualified to do business in the State of Maryland and that it will remain qualified;
- D. Contractor is not behind in the payment of any obligations due to the County and that it will not become behind during the term of this Contract;
- E. Contractor will comply with all applicable federal, State, local laws, regulations, and ordinances; and
- F. Contractor will obtain, at its expense, all licenses, permits, insurance, and governmental approvals needed to perform its obligations under this Contract.

Contingent Fee Prohibition. The Contractor warrants that it has not directed anyone, other than its employee or agent, to solicit this Contract and that it has not promised to pay anyone a commission, percentage, brokerage fee, contingent fee, or other consideration contingent on the making of this Contract.

Counterparts and Signature. This Contract may be executed in several counterparts, each of which may be an original and all of which will constitute the same instrument. Unless otherwise specified by the County, this Contract may be signed in writing or by electronic signature, including by email. An electronic signature, a facsimile copy, or computer image of this Contract will have the same effect as an original signed copy.

Force Majeure. The parties are not responsible for delay or default caused by fire, riot, acts of God, County-declaration-of-emergency, or war beyond their reasonable control. The parties must make all

reasonable efforts to eliminate a cause of delay or default and must, upon cessation, diligently pursue their obligations under the Contract.

Governing Law. This Contract is governed by the laws of the State of Maryland and Wicomico County.

Indemnification. The Contractor will indemnify the County, its officers, agents, and employees from all liability, penalties, costs, losses, damages, expenses, causes of action, claims, or judgments (including Attorney's fees) resulting from injury to or death of any person or damage to property of any kind, which injury, death, or damage arises out of, or is in any way connected with the performance of the work or failure to perform its obligations under this Contract.

This obligation applies to any acts, omissions, or negligent conduct, including acts or omissions of Contractor's agents or employees, except that it is not applicable to injury, death, or damage to the property arising from the sole negligence of Wicomico County, its officers, agents, or employees.

Independent Contractor.

- A. Contractor is an "Independent Contractor." Although the County may determine the delivery schedule for the work and evaluate the quality of the work, the County will not control the means or manner of the Contractor's performance. The Contractor will comply promptly with County requests relating to the emphasis to be placed on aspects of the work. But Contractor is responsible for determining the appropriate means and manner of performing the work.
- B. Contractor warrants that Contractor is not an employee of the County, is not currently employed by the Federal Government, and is not an officer, employee, or agent of the County.
- C. Contractor is responsible for all federal or state taxes applicable to any compensation or payments paid to Contractor under this Contract. Contractor is not eligible for any federal Social Security, unemployment insurance, or workers' compensation benefits from compensation paid to Contractor.
- D. Contractor agrees to immediately provide the County notice of any claim made against Contractor by any third party. Contractor also agrees not to assign to any third party, without the County's written consent, any obligation of the County to indemnify Contractor for any actions under this Contract.

Insurance Requirements.

- A. Contractor must obtain and keep in effect Commercial General Liability Insurance in the amounts listed below for its activities and operations. The insurance must include coverage for personal injury, discrimination, and civil rights violation claims. All insurance must name County, its employees, and agents as "ADDITIONAL INSURED". A copy of the certificate of insurance must be filed with the County prior to the time this Contract is executed, providing coverage in the amount of \$1,000,000 per occurrence, \$2,000,000 general aggregate, and \$500,000 for property damage. Coverage must be written on an occurrence form.
- B. Contractor must obtain and keep in effect, automobile insurance on all vehicles used in this Contract to protect Contractor against claims for damages resulting from bodily injury, including wrongful death, and property damage that may arise from the operations of any owned or hired automobiles used by Contractor in connection with the Contract. All insurance must name County, its employees, and agents as "ADDITIONAL INSURED".
- C. Contractor must provide the County with a certification of Workers' Compensation Insurance, with employer's liability in the minimum amount required by Maryland law in effect for each year of this Contract.

- D. All insurance policies must have a minimum 30 days' notice of cancellation. The County must be notified immediately upon cancellation or restriction by the insurance company of any insurance policy referred to in this section.
- E. When insurance coverage is renewed, Contractor must provide new certificates of insurance prior to expiration of current policies.

Nondiscrimination. Contractor may not discriminate against any worker, employee, or applicant because of religion, race, sex, age, sexual orientation, physical or mental disability, or perceived disability. Contractor agrees that this provision will be incorporated in all subcontracts related connection to this Contract.

Ownership of Documents and Materials; Intellectual Property.

- A. The Contractor agrees that all documents, including reports, drawings, studies, specifications, estimates, maps, photographs, designs, graphics, mechanicals, artwork, or computations prepared for this Contract will be available to the County upon request and become the exclusive property of the County upon termination or completion of the services. The County has the right to use the documents without restriction or without additional compensation to the Contractor. The County will be the owner of the documents for the purposes of copyright, patent, or trademark registration.
- B. If the Contractor obtains, uses, or subcontracts for any intellectual property, then it must provide an assignment to the County of ownership or use of the intellectual property.
- C. The Contractor must indemnify the County from all claims of infringement related to the use of any patented design, device, materials, or process, or any trademark or copyright, and must indemnify the County, its officers, agents, and employees with respect to any claim, action, costs, or infringement, for royalties or user fees, arising out of purchase or use of materials, construction, supplies, equipment, or services covered by this Contract.

Payments. Payments to the Contractor pursuant to this Contract will be within 30 days of the County's receipt of a proper invoice from the Contractor. If an invoice remains unpaid 45 days after the invoice was received, interest will be charged at a rate of 6% per year.

Records. Contractor must maintain all fiscal records relating to this Contract in accordance with generally accepted accounting principles. Contractor must maintain any other records pertinent to this Contract in a manner that clearly documents Contractor's performance. Contractor agrees that the County and its agents can all records of the Contractor that are relevant to this Contract. All relevant records must be retained by Contractor and kept accessible for at least three years after final payment, termination of this Contract, or until the conclusion of any audit, controversy, or litigation related to this Contract, whichever is later. All subcontracts must comply with these provisions.

Remedies.

- A. Corrections of errors, defect and omissions. Contractor agrees to perform work necessary to correct errors, defects, and omissions in the services required under this Contract, without undue delays and without cost to the County. The County's acceptance of the work will not relieve the Contractor of the responsibility of subsequent corrections of errors.
- B. Set Off. The County may deduct from any amounts payable to the Contractor any back-charges, penalties, or damages sustained by the County, its agents, or employees caused by Contractor's breach. Contractor will not be relieved of liability for any costs caused by a failure to satisfactorily perform the services.

- C. Cumulative. These rights and remedies of County and Contractor are cumulative and without waiver of any other rights or remedies.

Responsibility of Contractor.

- A. The Contractor must perform the services with the standard of care, skill, and diligence normally provided by a Contractor in the performance of services similar the services.
- B. Notwithstanding any review, approval, acceptance, or payment for the services by the County, the Contractor will be responsible for the accuracy of any work, design, drawings, specifications, and materials furnished by the Contractor under this Contract.
- C. If the Contractor fails to perform the services in conformance with the standard set forth in subparagraph A above, then it must, if required by the County, perform at its own expense any service necessary for the correction of any deficiencies or damages resulting from the Contractor's failure. This obligation is in addition to any other remedy available to the County.

Severability/Waiver. If a court finds any term of this Contract to be invalid, the validity of the remaining terms will not be affected. The remaining terms will be construed as if the Contract did not contain the invalid term. The failure of either party to enforce any term of this Contract is not a waiver by that party.

Subcontracting or Assignment. The Contractor may not subcontract or assign any part of the Contract without the prior written consent of the County. The County has the right to withhold consent for any reason the County deems appropriate.

Substance Abuse and Drug Testing. Contractors and its employees are subject to the County's policy on substance abuse and drug testing for the use, possession, or sale of drugs or alcohol while performing County business or while in a County facility. Violation or refusal to cooperate may result in a ban from County facilities or from participating in County operations.

Survival. The terms, conditions, representations, and all warranties contained in this Contract survive the termination or expiration of this Contract.

Termination. If the Contractor violates any provision of the Contract, the County may terminate the Contract by written notice to the Contractor. The notice will specify the cause for termination. All finished or unfinished work provided by the Contractor will, at the County's option, become the County's property. The County will pay the Contractor fair compensation for satisfactory performance that occurred before termination less the amount of damages caused by the Contractor's breach. If the damages are more than the compensation payable to the Contractor, the Contractor will remain liable after termination and the County can affirmatively collect damages.

Termination of Contract for Convenience. Upon written notice, the County may terminate the Contract, in whole or in part, when the County determines termination is in the County's best interest. Termination for convenience is effective on the date specified in the County's written notice. The County will pay for reasonable costs allocable to the Contract for work or costs incurred by the Contractor up to the date of termination. But the Contractor will not be reimbursed for any anticipatory profits that have not been earned up to the date of termination.

Termination of Multi-year Contract. If funds are not available for any fiscal period of this Contract after the first fiscal period, then this Contract will be cancelled automatically as of the beginning of unfunded fiscal period. The effect of termination of the Contract will be to discharge both the Contractor and the County from future performance of the Contract but not from their rights and obligations existing at the time of termination. The Contractor will be reimbursed for the reasonable value of any non-recurring costs incurred but not amortized in the price of the Contract. The County will notify the Contractor if it

has knowledge that funds are not available for the continuation of this Contract for a fiscal period beyond the first period.

Third Party Beneficiaries. The County and Contractor are the only parties to this Contract and are the only parties entitled to enforce its terms. Nothing in this Contract gives any benefit or right to third persons unless individually identified by name and expressly described as intended beneficiaries of the terms of this Contract.

Time is of the essence. Time is of the essence in Contractor's performance of each and every obligation and duty under this Contract.

Use of County Facilities. Contractor and its employees or agents have the right to use only those facilities of the County that are necessary to perform the services under this Contract. County has no responsibility for the loss, theft, disappearance of or damage to equipment, tools, materials, supplies, or other personal property of Contractor or its employees, subcontractors, or agents which may be stored on County premises.

Whole Contract. This Contract constitutes the complete and exclusive statement of the Contract between the parties relevant to the purpose described and supersedes all prior agreements or proposals, oral or written, and all other communication between the parties relating to the subject matter of this Contract.

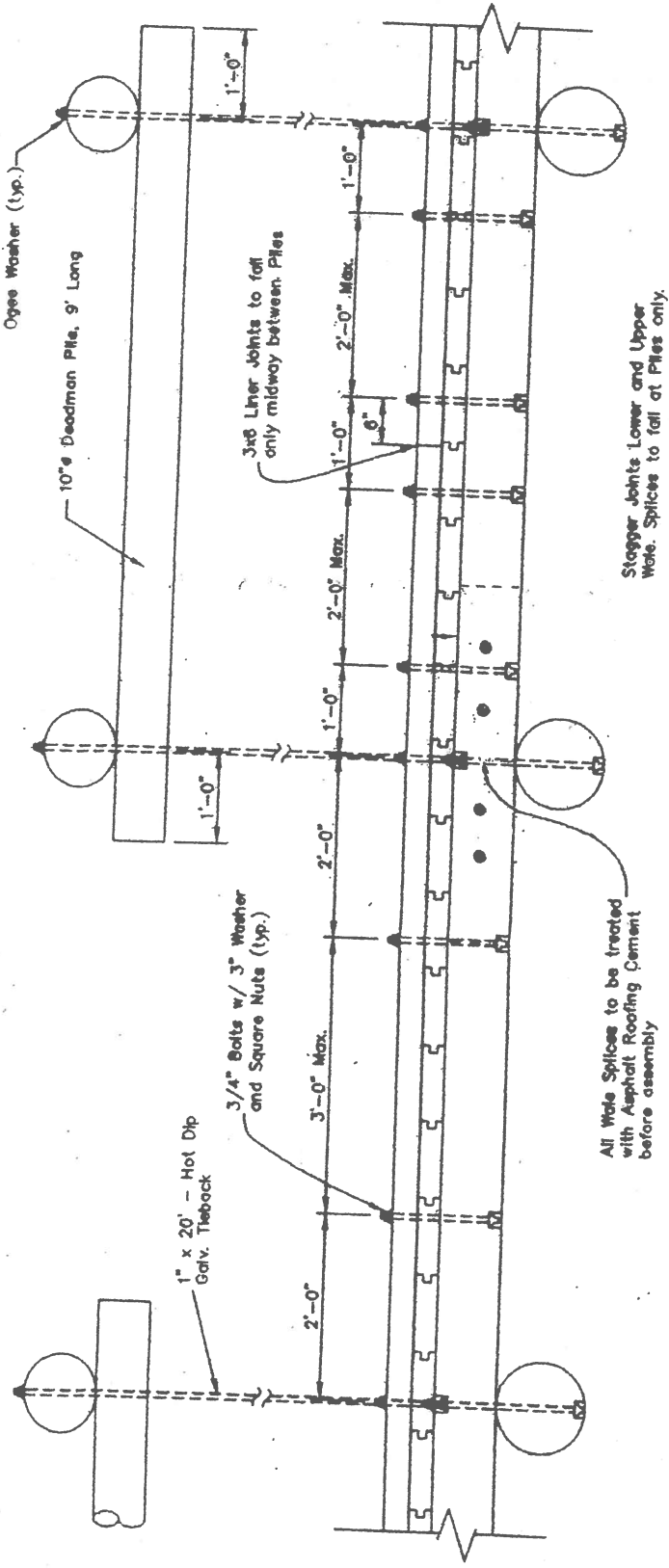

PLAN

BULKHEAD WITH TIEBACKS

No Scale

All Weld Splices to be treated with Asphalt Roofing Cement before assembly

Stagger Joints Lower and Upper Wale. Splices to fall at Piles only.

$3/8''$ Liner Joints to fall only midway between Piles

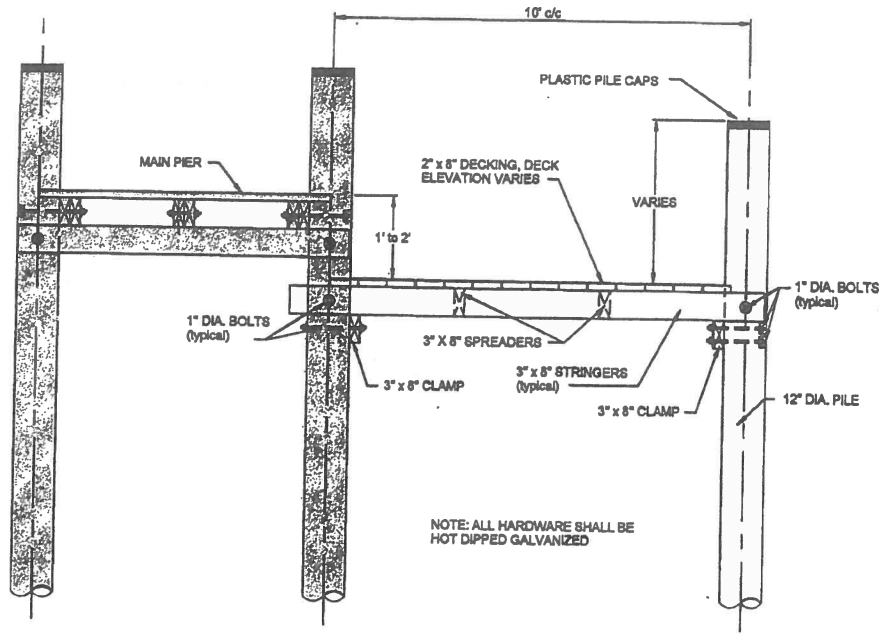

ELEVATION VIEW

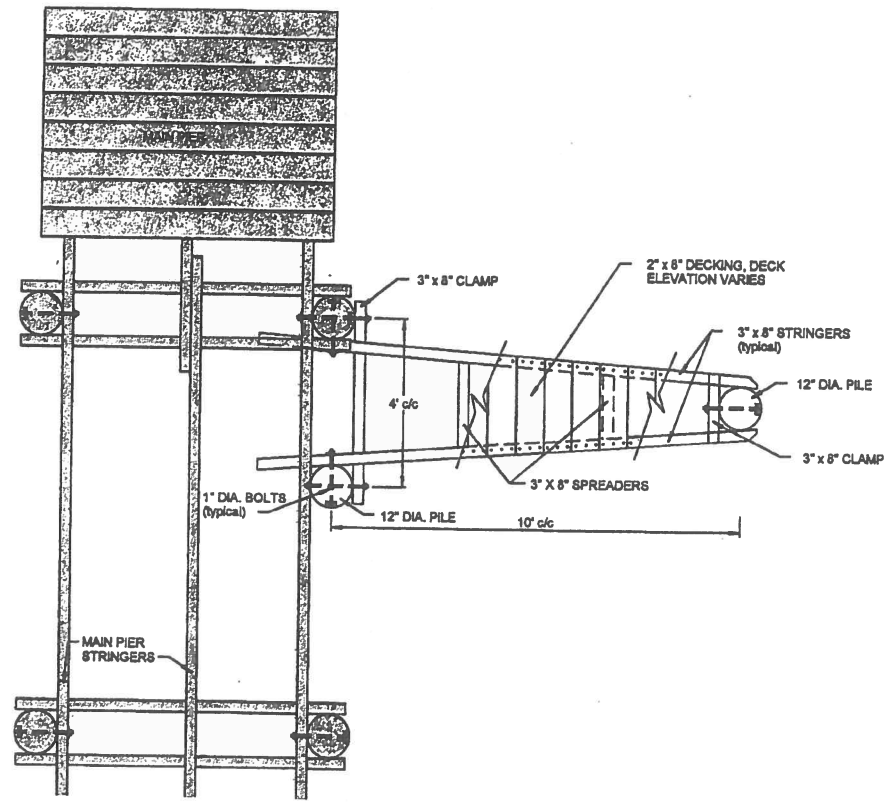

PLAN VIEW

TYPICAL 10' FINGER PIER DETAIL
(NO SCALE)



MARYLAND
DEPARTMENT OF
NATURAL RESOURCES

TYPICAL FINGER PIER

BOATING SERVICES
TAWES STATE OFFICE BUILDING
580 TAYLOR AVE., E-4
ANNAPOLIS, MD 21401

DATE:
MAY, 2008

Drawing Number:

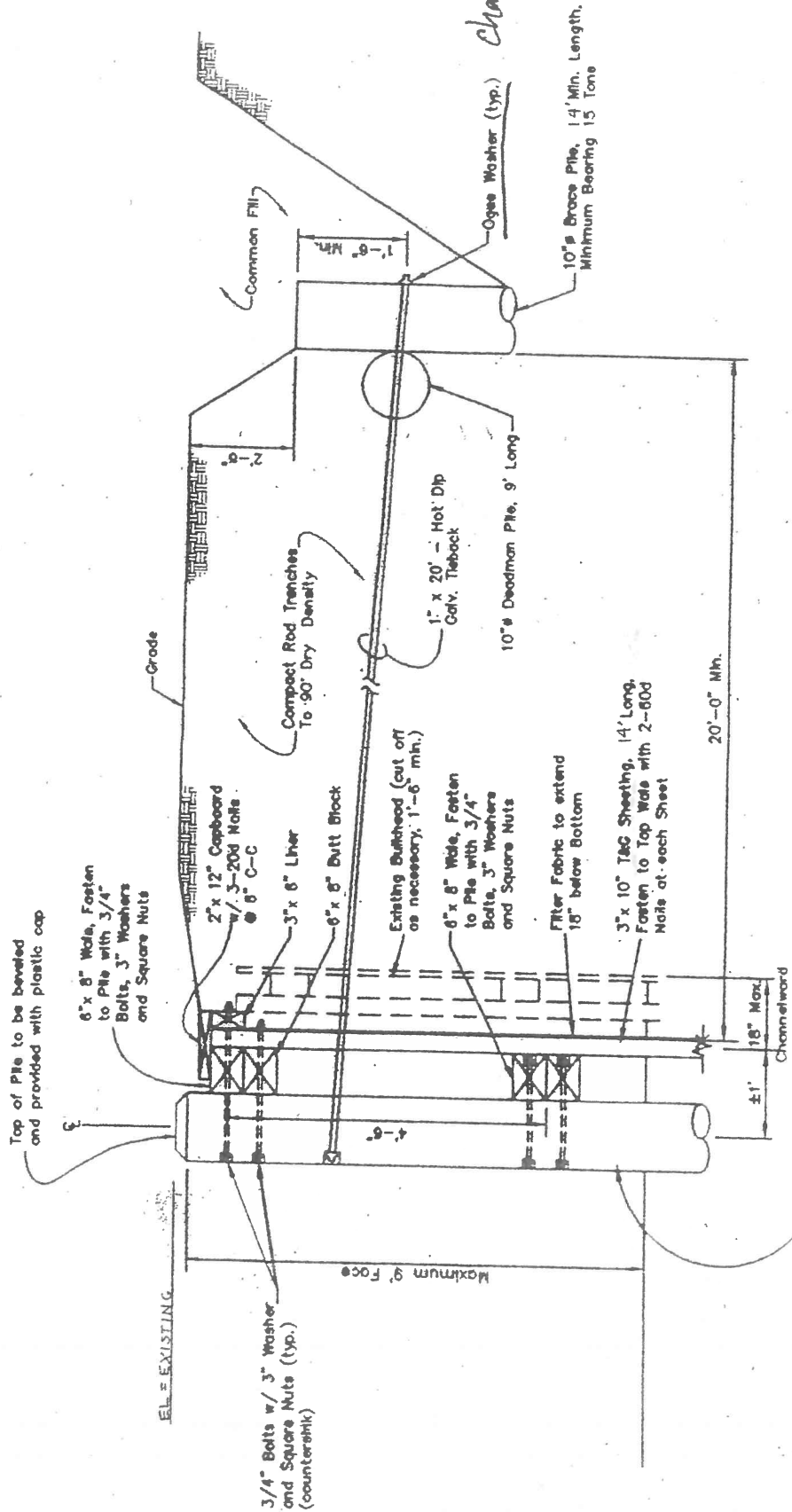

Change to dock washer.

- 12" Dia. Pile, 30' Min. Length.
- 7'-0" O.C. where Face is < 8'.
- 6'-8" O.C. where face is > 8'.
- Min. Capacity of Tons

SECTION

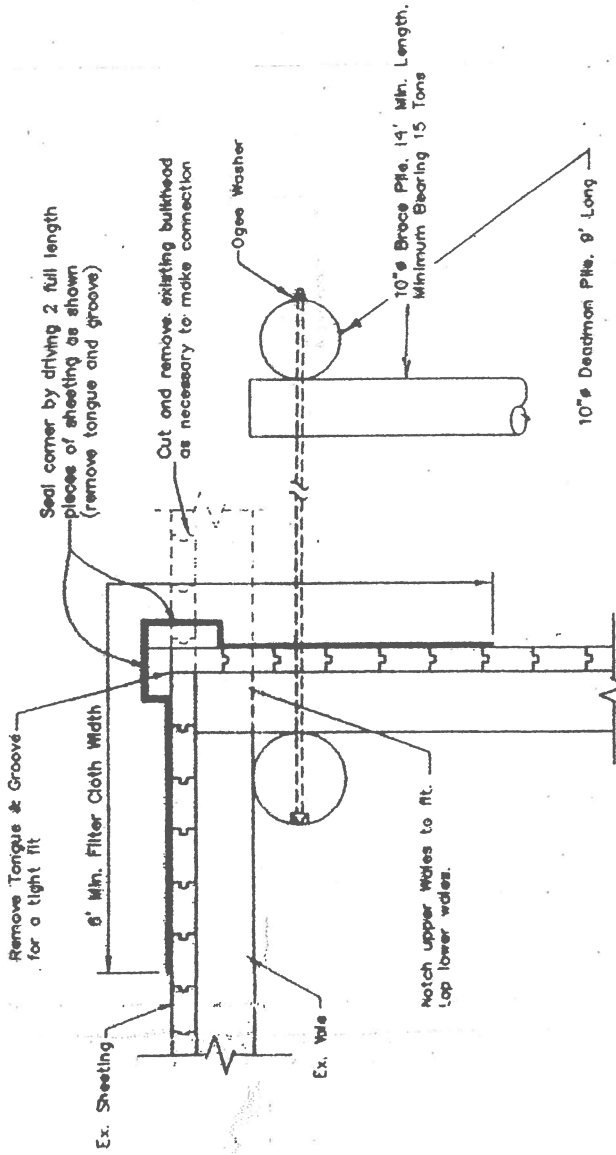

BULKHEAD CONNECTION DETAIL A

No Scale

Copboard Splice to Fall at Random

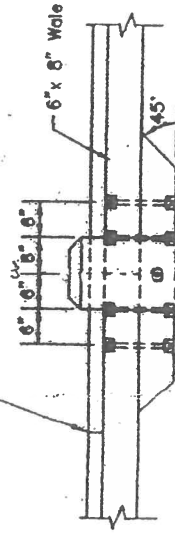

6" x 8" x 4' Timber Butt Block Bolted to Top Wale w/ 3/4" Galv. Bolts and 3" x 1/4" Galv. N.Y.D.D. Washers Countersunk in Wale and Galv. Nut and 3" x 1/4" Galv. N.Y.D.D. Washers on Bottom

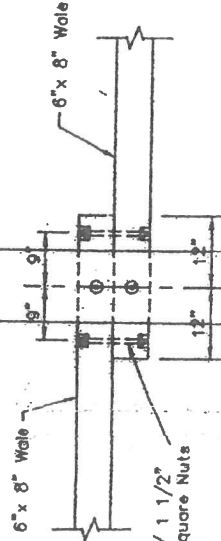

3/4" Bolts w/ 1 1/2" Washer and Square Nuts

WALE & BUTT BLOCK DETAIL (TYP.)

No Scale